

# MATRIX<sup>®</sup> 430

## USER GUIDE

Entry level guidance  
Software version 1.02



**TeeJet<sup>®</sup>**  
TECHNOLOGIES

A Subsidiary of  Spraying Systems Co.<sup>®</sup>

# GETTING STARTED

1. Power on the console.

## Setup machine

2. On guidance screen, press NAVIGATION AND GUIDANCE OPTIONS tab to display options.

3. Press HOME button .

4. Press CONSOLE button .

- ▶ LCD Brightness
- ▶ Color scheme
- ▶ Units
- ▶ GNSS demo mode
- ▶ Screenshot
- ▶ Time zone
- ▶ Console information

5. Press HOME button .

6. Press CONFIGURATION button .

- ▶ Machine Configuration
- ▶ Lightbar spacing
- ▶ GNSS

## Setup guidance

7. From the Home screen, press GUIDANCE button .

8. On guidance screen, press NAVIGATION AND GUIDANCE OPTIONS tab to display options.

- ▶ Guidance mode – Straight AB guidance , Curved AB guidance , Circle pivot guidance , Last pass guidance or no guidance
- ▶ Create AB guideline
- ▶ Create boundary
- ▶ Set return point

## Start mapping

9. Press VEHICLE icon in the center of the guidance screen to turn on or off application mapping.

## Guidance screen includes

- ▶ Selectable information – Speed , total applied area , application time or swath number
- ▶ Lightbar and Navigation Activity – GNSS status, cross track error or current activity
- ▶ Status Bar – GNSS , guidance mode , boundary area and Application mapping status
- ▶ A+ nudge feature
- ▶ Zoom

## Start new job

To start a new job, delete old job data.

1. From the Home screen, press DATA button .
2. Press RECYCLE button .



## MATRIX 430 CONSOLE

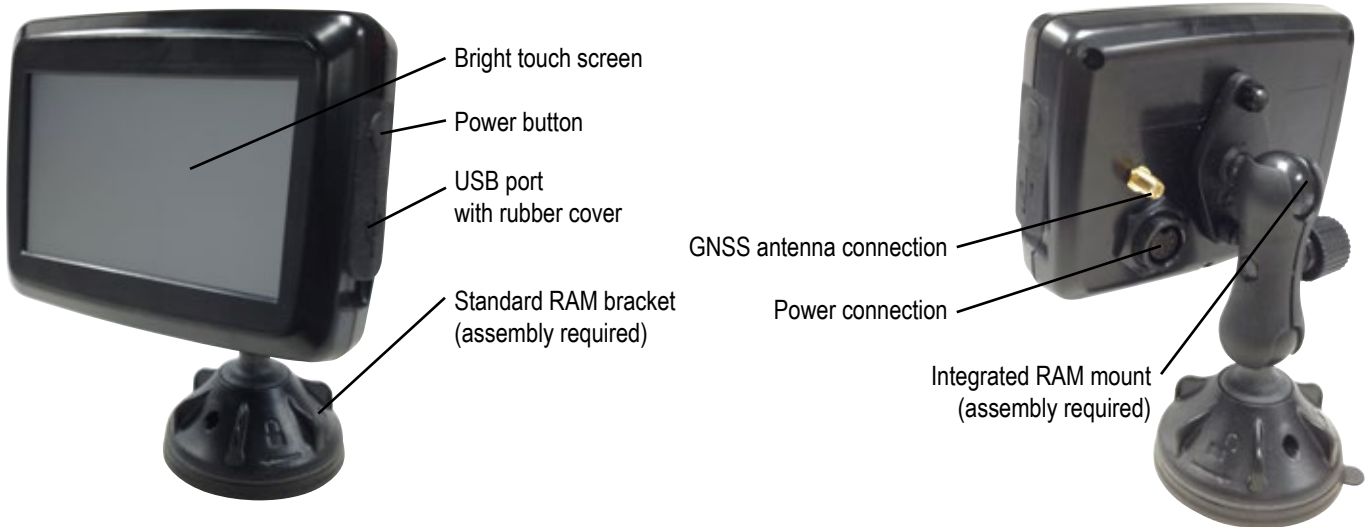

### System components

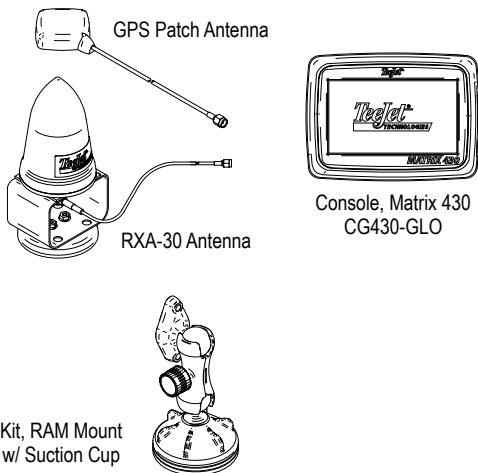

#### Power Cables

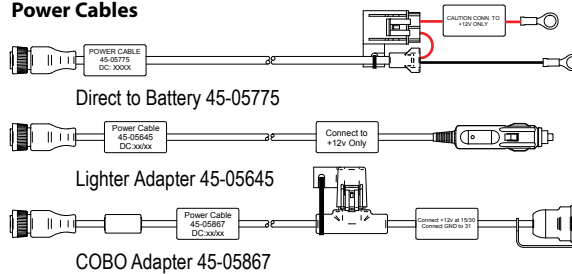

#### Power/Sense/Speed Cables

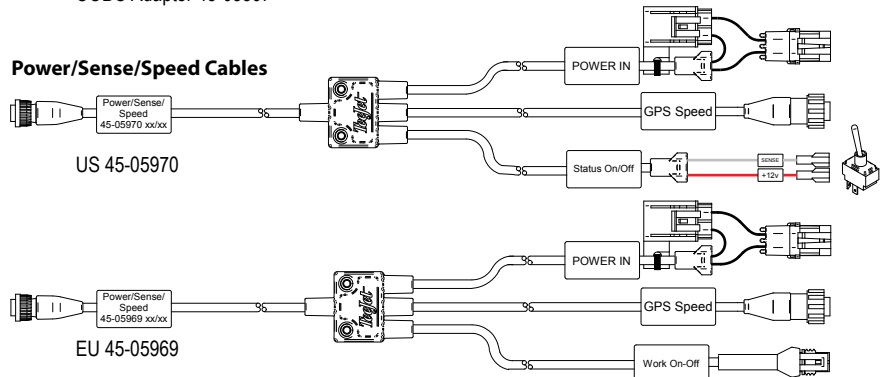

All changes are saved automatically.

The console needs to be cycled off and back on when changing or attaching equipment to the Matrix 430 system.

### Recommended antenna installation

The GNSS antenna should be mounted as far forward as possible on top of the cab on a metal surface of at least 4"/10 cm square.

### Power on

1. Press POWER button

### Power off

1. Press POWER button
2. Select from:
  - ▶ Accept – to continue shut down
  - ▶ Cancel – to keep the console on.

**WARNING!** Wait 30 seconds before restarting the console after powering off.

## ICON REFERENCE

### Guidance

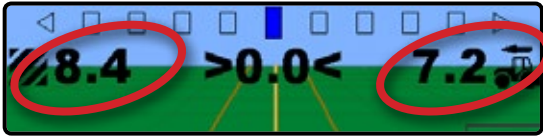

Selectable information

- Speed
- Total applied area
- Application time
- Swath number
- Show nothing

**A** **B** Mark A, Mark B

**A+** A+ nudge feature

Navigation and guidance options tab

- Home
- Guidance modes
  - Straight AB guidance
  - Curved AB guidance
  - Circle pivot guidance
  - Last pass guidance
  - No guidance
- Application boundary
  - Start
  - Finish
  - Cancel
  - Delete
- Return to point
  - Mark
  - Go to point
  - Cancel
  - Delete
- Close options
- Zoom in/out

### Configuration

Machine settings

- Number of implement sections
- Section widths
- In-line implement offset distance
- Lateral implement offset distance

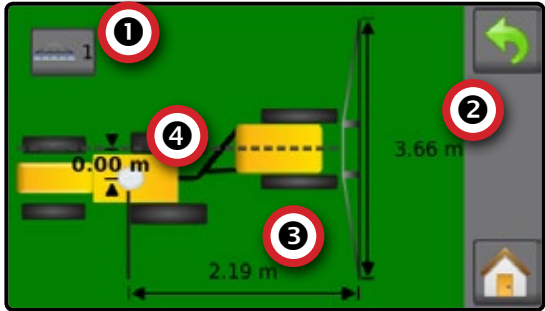

- Lightbar spacing
- GNSS receiver configuration

### Job Data

- Total applied area
- Bounded area
- Application time
- Delete
- Reports

### Console

- LCD brightness
- User interface colour scheme
- Units
  - Demonstration GNSS
    - GNSS
    - Demo
- Screenshot
- Time zone
- About

## KEYBOARD ENTRY SCREENS

To change a value:



1. Press CURRENT VALUE.
2. Use the numeric keypad to enter a new value.
3. Select from:
  - ▶ Accept  – to save the settings
  - ▶ Cancel  – to leave the keypad without saving

Figure 1: Example of keyboard



## HOME

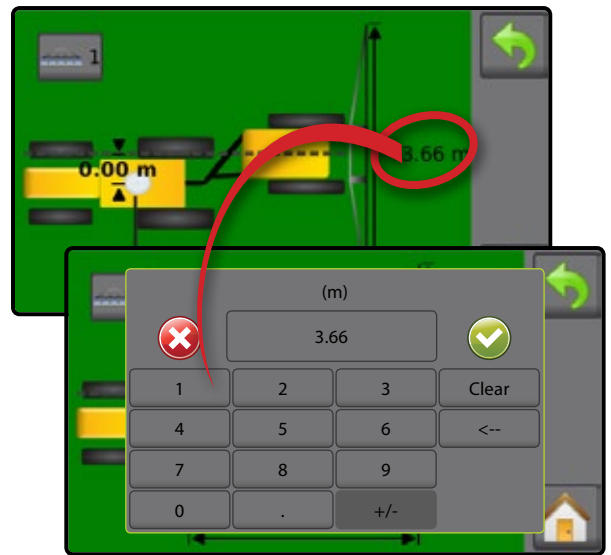
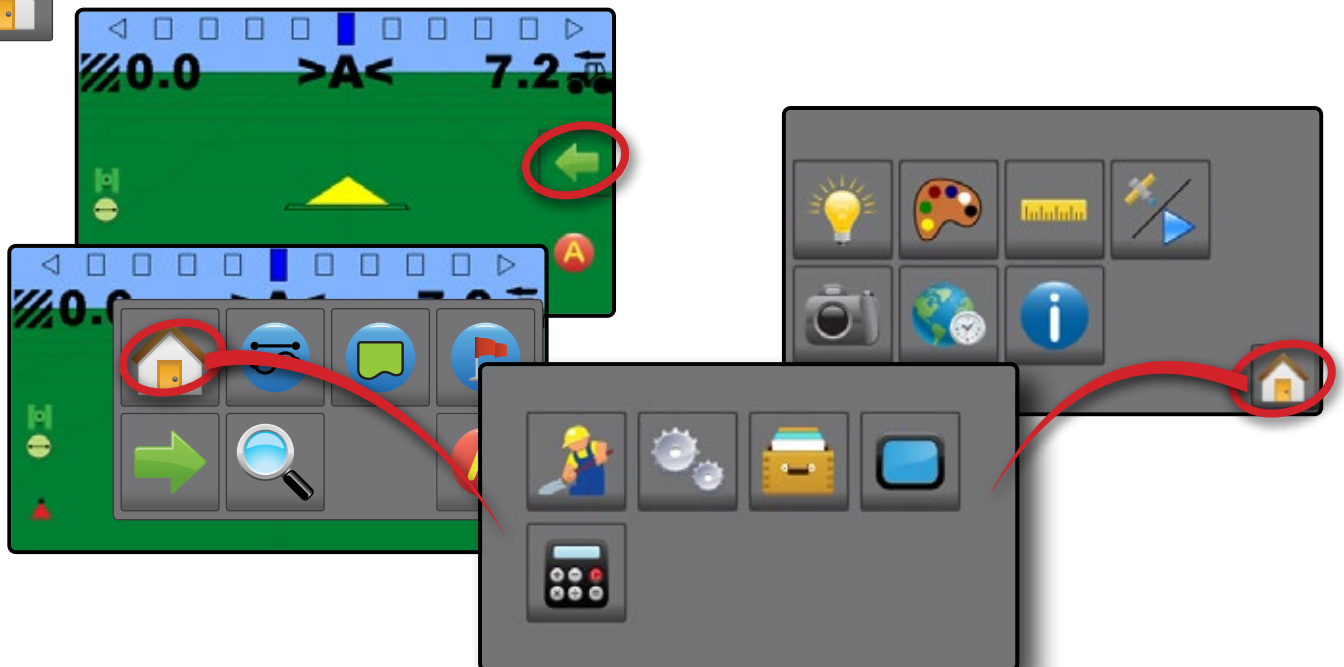

### Guidance

Used to view a computer-generated image of the vehicle position displayed in the application area. From this screen all setup and navigation options can be accessed via the tab on the right side of the screen.



### Configuration

Used to setup the machine settings, lightbar and GNSS receiver.



### Job data

Used to view or delete job data and export reports.



### Console

Used to setup LCD brightness, colour scheme, units, screenshot and time zone; start demonstration GNSS; and view console information.



### Calculator



## GUIDANCE

The Guidance Screen creates a computer-generated image of the vehicle position displayed in the application area. From this screen all setup and navigation options can be accessed via the tab on the right side of the screen.

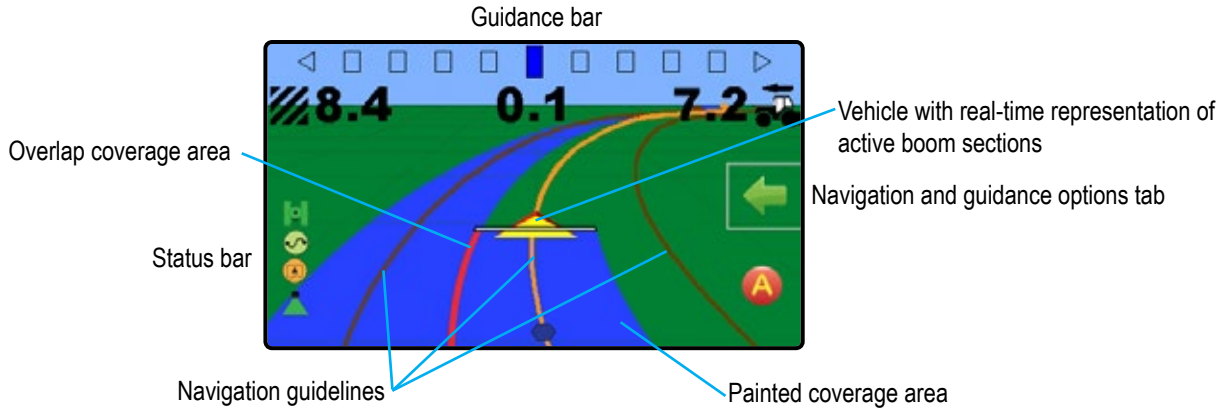

### Navigation and guidance options tab

Home – used to access Home screen

Guidance Modes – select one of five (5) guidance modes:  
 Straight AB guidance , Curved AB guidance , Circle pivot guidance , Last pass guidance , No guidance

Application Boundary – create or delete a boundary

Return to Point – create, guide to or delete a point

Close menu – used to close the Navigation and guidance options menu

Zoom In/Out – adjust the vehicle's view or perspective to the horizon from vehicle view to bird's eye view

Guidelines – establish an AB guideline or shift line to the vehicle's current location

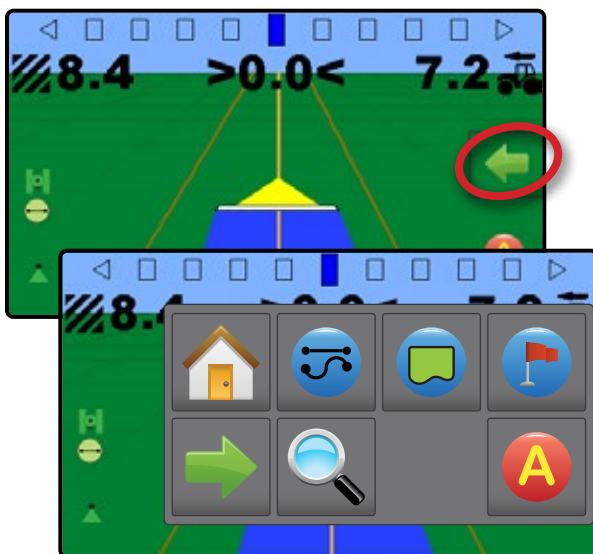

### On screen guidance



- Guidelines:
  - ◀ Orange – active guidance line
  - ◀ Brown (multiple) – adjacent guidance lines
  - ◀ Black – boundary line
- Points – markers for established points:
  - ◀ Red point – Return to point
  - ◀ Blue point – Mark A
  - ◀ Green point – Mark B
- Coverage area – illustrates applied area and overlap:
  - ◀ Blue – one application
  - ◀ Red – two or more applications
- Zoom in/out & perspective – adjusts the vehicle's view or perspective to the horizon from vehicle view to bird's eye view.
- Boom Sections:
  - ◀ Empty box – inactive boom
  - ◀ White box – active boom

### Status bar

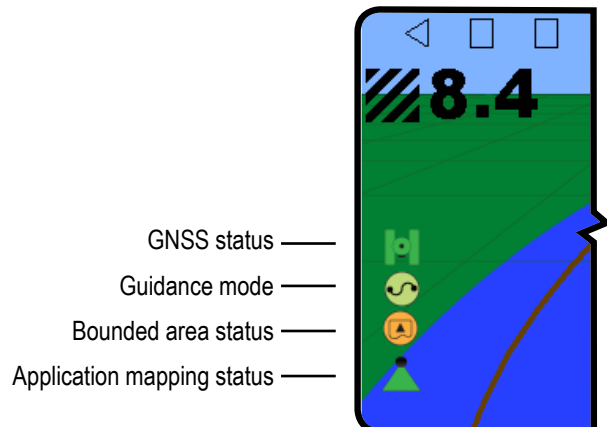



The status bar provides information on GNSS status, guidance mode, boundary area, and implement control status.





## GNSS status

-  Red = no GNSS
-  GPS only
-  Green = DGPS, WAAS/RTK, GLONASS



## Guidance mode

-  Straight AB guidance
-  Curved AB guidance
-  Circle pivot guidance
-  Last pass guidance
- No icon = no guidance

## Bounded area status

-  Outside boundary = currently traveling outside bounded area
-  Inside boundary = currently traveling inside bounded area
- No icon = no boundary established

## Application mapping status

-  Red = off
-  Green = on

## Status/information screens

To display information:

1. Press status bar icon.
  - ▶ GNSS status  – displays information regarding number of satellites in view, satellite quality and receiver ID

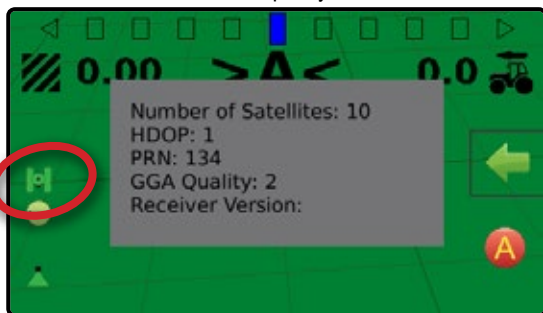

- ▶ Bounded area status  – displays information regarding the area in the current boundary

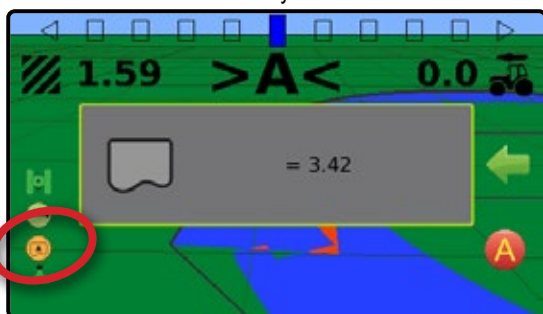

To remove the information box, tap the information box.

## Guidance bar

The guidance bar keeps you informed of your choice of selectable information (current speed, total applied area, application time, swath number) and navigation activity (cross track error, current activity and GNSS status).

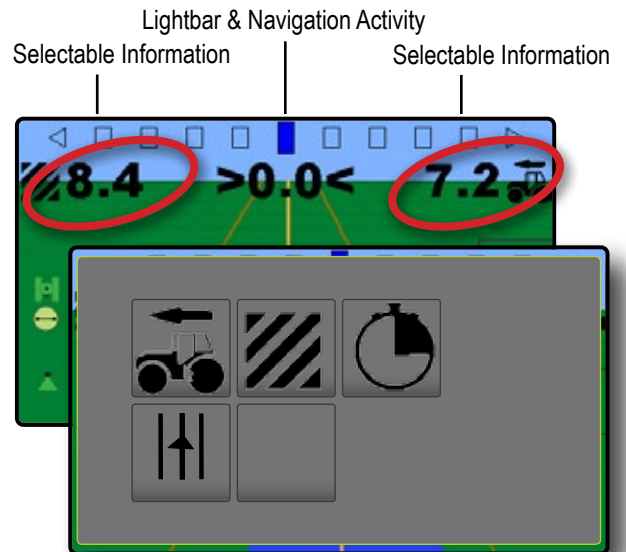

## Lighbar & navigation activity

Lightbar spacing – used to represent the distance away from the guideline or vehicle.

GNSS status – displays flashes “GPS” when GNSS is unavailable

Cross track error – displays the distance from your desired guideline



Current activity – displays activities such as mark an A or B point and distance to return to a marked point

## Selectable information

Speed  – displays the current speed of travel

Total applied area  – displays the total accumulated area that has had application applied including double coverage areas

Application time  – displays the total time application is active during the current job



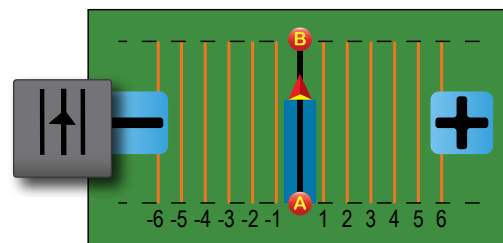



Swath number   – displays the current swath number in reference to the initial guidance line. Number will be shown as a positive number when the vehicle is to the right of the AB baseline or a negative number when the vehicle is to the left of the AB baseline





No information  – shows no information in the display area

## Guidance Modes

To choose a Guidance Mode:

1. Press NAVIGATION AND GUIDANCE OPTIONS tab  to display navigation options.
2. Press GUIDANCE MODE button .
3. Select from:
  - ▶ Straight AB guidance 
  - ▶ Curved AB guidance 
  - ▶ Circle pivot guidance 
  - ▶ Last pass guidance 
  - ▶ No guidance 

NOTE: Offset to adjacent guidelines will be calculated using the guidance width, which is encoded in Machine setup  in the Configuration  options.

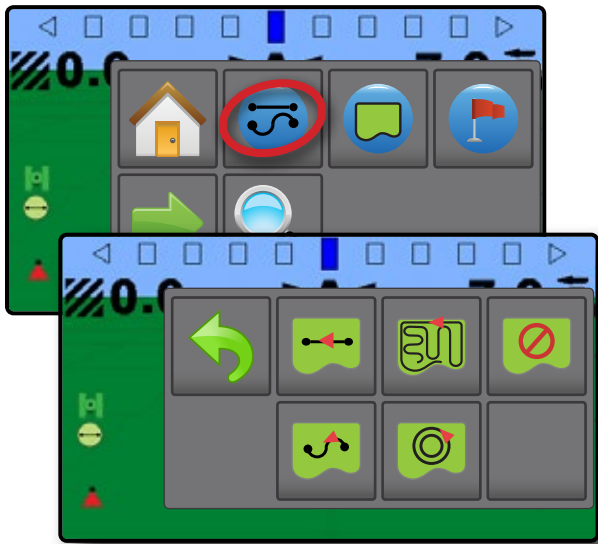

### Straight AB guidance

Straight AB guidance provides straight line guidance based on A and B reference points. The original A and B point are used to calculate all other parallel guidelines.

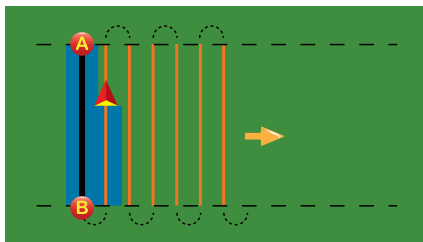

### No guidance

No guidance turns off guidance.

NOTE: No guidance mode does not delete established guide lines or points from the console. To delete established/saved data from the console, please refer to the Data management section under Unit setup.

### Last pass guidance

Last pass guidance offers true last pass navigation. The console will automatically detect the nearest applied area and establish parallel guideline based on that area.

NOTE: If a boundary is established but no application occurred during the boundary process, guidance will not initiate.

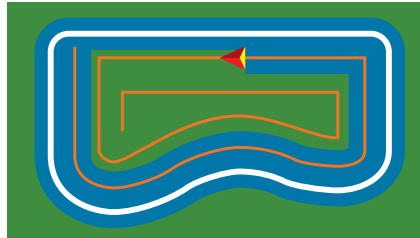

### Curved AB guidance

Curved AB guidance provides guidance along curved lines based on an initial AB reference line. This initial baseline is used to calculate all other guidelines.

NOTE: Curved guidance is recommended not to exceed 30° within the AB guideline.

HINT: While working in a bounded area, the guidance pattern extending beyond the established AB points will be straight line guidance.

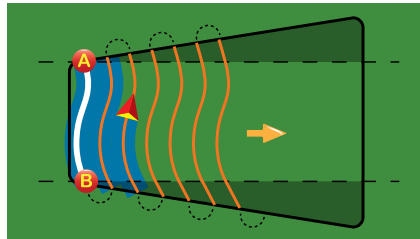

### Circle pivot guidance

Circle pivot guidance provides guidance around a central location that radiates inward or outward based on an initial AB reference line. This initial baseline is used to calculate all other guidelines.

It is used for product application in a centre pivot field while being guided along a circular guideline that matches a centre pivot irrigation system radius.

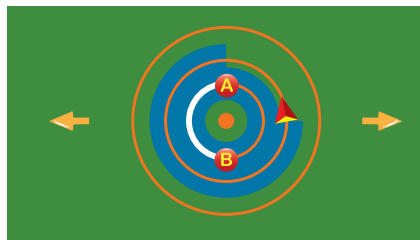









## A Guidelines

### A B Marking A and B points

To establish an AB guideline:



1. Drive to the desired location of Point A .
2. **While the vehicle is in motion**, press MARK A icon .
 

*NOTE: a Mark A button  is also available on the Navigation and guidance options  menu*
3. Drive to the desired location of Point B .
4. Press MARK B button  to establish the AB line.

The console will begin providing navigation information.

*NOTE: The MARK B Icon  is not available for selection (greyed out) until the minimum distance is travelled (3.0 metres in Straight or Curved guidance, 50.0 metres in Circle pivot guidance).*

*It is not necessary to drive the entire circumference of the centre pivot in order to initiate Circle pivot guidance.*

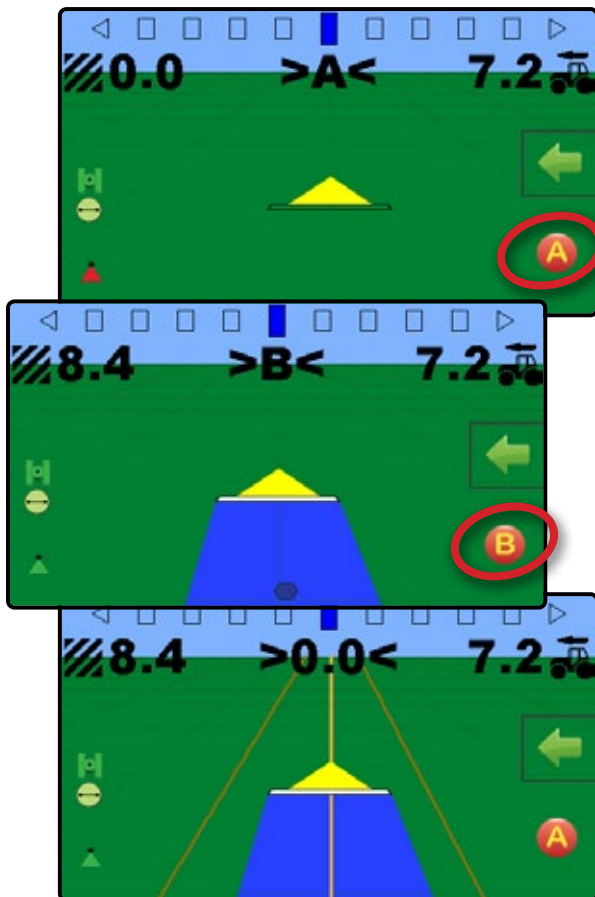

Use CANCEL MARK button  on the Navigation and guidance options  menu to cancel the Mark A command and revert to the previous guideline (when established).



### A+ A+ nudge feature

The A+ nudge feature allows the current guideline to be shifted to the vehicle's current location.

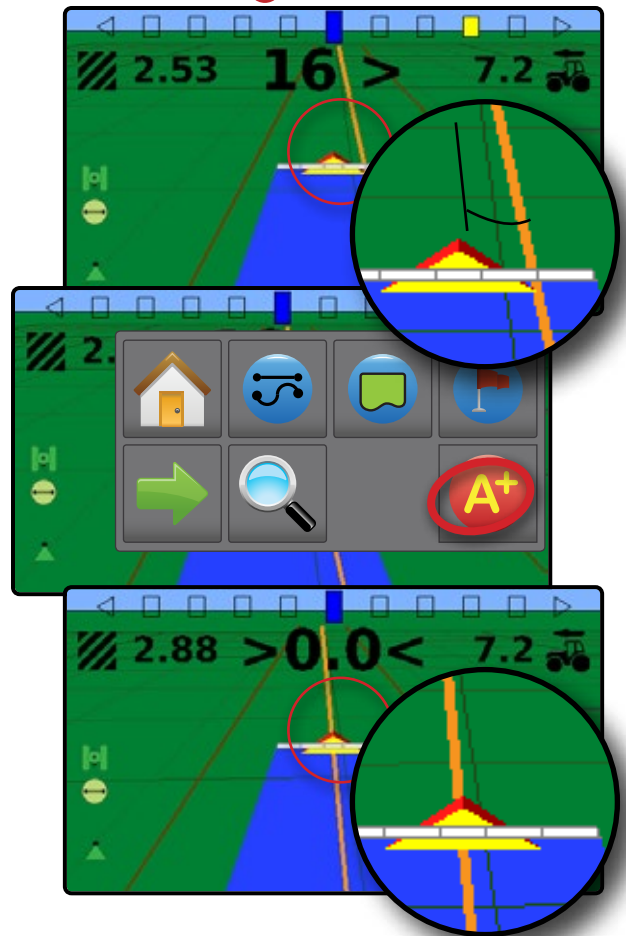

To adjust the guideline:

1. Press NAVIGATION AND GUIDANCE OPTIONS tab  to display navigation options.
2. Press A+ NUDGE button .



## Application Boundary



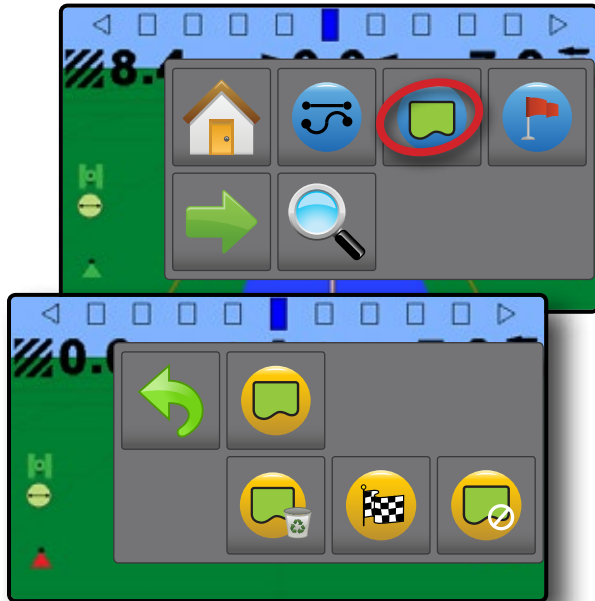

Application boundaries establish areas where application is and is not to be applied. Boundaries can be established in all guidance modes. One exterior boundary can be stored at a time.

In correspondence to your current location, the IN BOUNDARY icon  or OUT BOUNDARY icon  is displayed on the status bar once the boundary is established.





### Creating a boundary

To establish an application boundary:

1. Drive to a desired location at the perimeter of the field/ application area.
2. Press NAVIGATION AND GUIDANCE OPTIONS tab  to display navigation options.
3. Press BOUNDARY button .
4. While the vehicle is in motion, press BOUNDARY button .
5. Travel the perimeter of the field/area.
6. Finish boundary:
  - ▶ Travel to within one swath width of the starting point. The boundary will close automatically (the white boundary line will turn black)
  - ▶ Press BOUNDARY FINISH button . A straight line will complete the boundary between your current location and the starting point

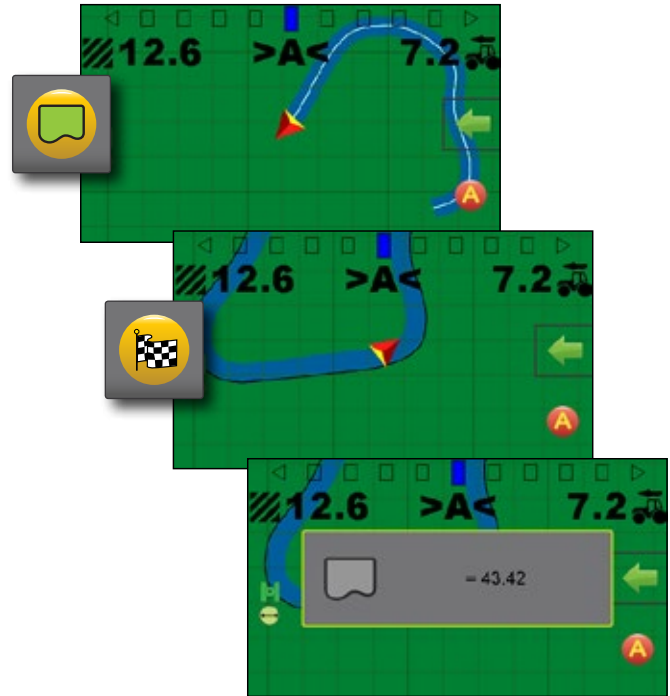

**NOTE:** The BOUNDARY FINISH button  is not available for selection (greyed out) until the minimum distance is travelled (five-times the swath width).

Use CANCEL BOUNDARY button  under Boundary  on the Navigation and guidance options  menu to cancel the new field boundary process and revert to the previous boundary (when established).



### Delete the boundary

To delete the established boundary:

1. Press NAVIGATION AND GUIDANCE OPTIONS tab  to display navigation options.
2. Press BOUNDARY button .
3. Press DELETE BOUNDARY button .

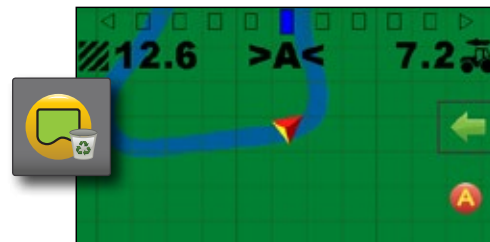

## Return to Point





Return to point provides guidance back to an established point. An arrow directs the vehicle back to the established point.

A return point will remain active until deleted.



### Marking a return point

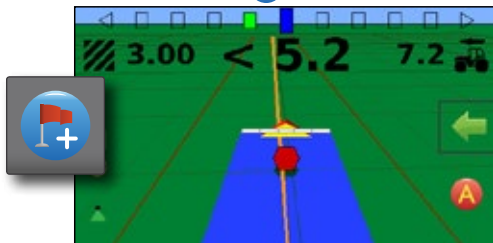

To mark a return point:

1. Drive to the desired location of return point .
2. Press NAVIGATION AND GUIDANCE OPTIONS tab  to display navigation options.
3. Press RETURN TO POINT button .
4. Press ADD POINT button .



### Delete the return point

To delete the established return point:

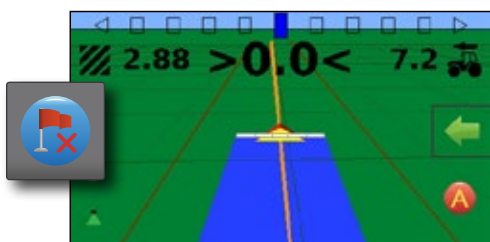

1. Press NAVIGATION AND GUIDANCE OPTIONS tab  to display navigation options.
2. Press RETURN TO POINT button .
3. Press DELETE POINT button .

Delete point button is not available while return to point guidance is active.





### Guidance to a return point

To show distance and guidance to the established return point:

1. Press NAVIGATION AND GUIDANCE OPTIONS tab  to display navigation options.
2. Press RETURN TO POINT button .
3. Press RETURN TO POINT GUIDANCE button .

The console will begin providing the distance information on the guidance bar from the vehicle to the established point.

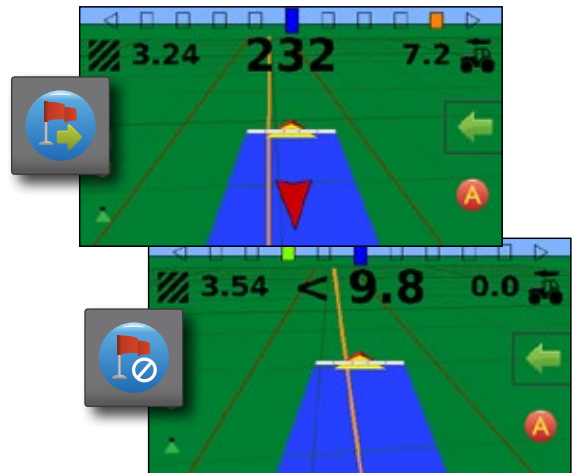

Use CANCEL RETURN TO POINT GUIDANCE button  under Return to point  on the Navigation and guidance options  menu to hide distance and guidance to the established point.

Guidance cannot be calculated when “?” appears in the guidance bar.



### Zoom In/Out

Zoom in/out & perspective is used to adjust the vehicle's view or perspective to the horizon from vehicle view to bird's eye view.

- Zoom in  will adjust view to vehicle view displaying a compass on the horizon
- Zoom out  will adjust view to bird's eye view

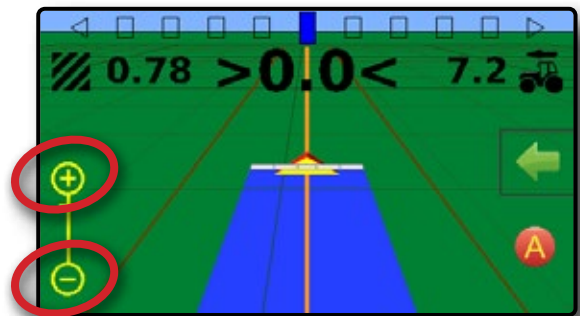

## Application Mapping & Applied alert



Application mapping is used to map coverage areas and flash and sound alerts when entering and existing previously mapped applied areas to alert the operator to turn on or shut off application.

*NOTE: Application mapping does not control actual application.*

### Mapping with console only

To switch mapping and alerts off or on using the console:

1. Press vehicle  in the center of the screen.

- ◀ Mapping and alerts on – status bar icon will change to green 
- ◀ Mapping and alerts off – status bar icon will change to red 

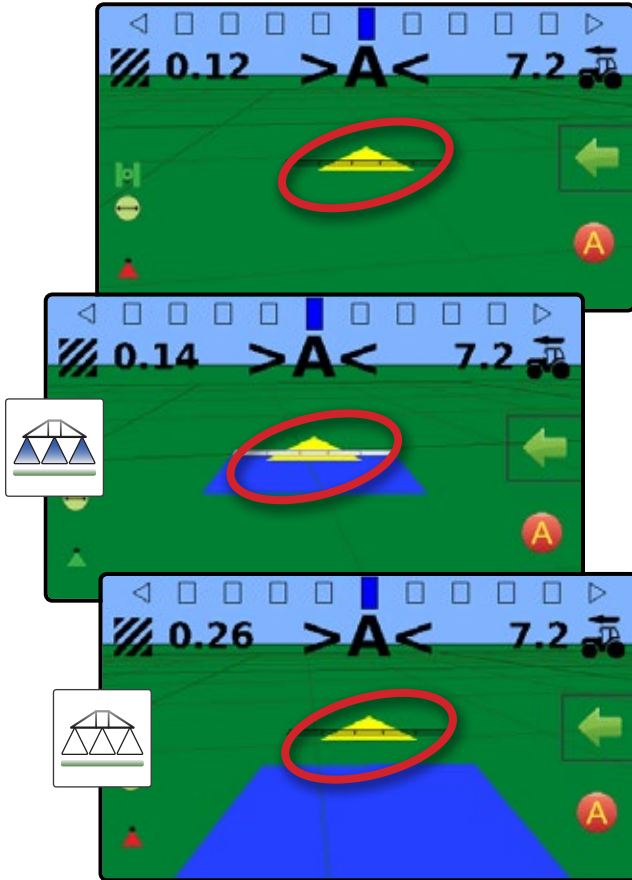



### Mapping with work on/off switch

When installed, the work on/off switch should remain in the “off” position for all setup options.

To switch mapping and alerts off or on using the switch:



1. Turn the switch to the “On” or “Off” position.

- ◀ Mapping and alerts on – status bar icon will change to green 
- ◀ Mapping and alerts off – status bar icon will change to red 

To switch mapping and alerts off or on using the console while a switch is attached:

1. Turn the switch to the “Off” position.

2. Press vehicle  in the center of the screen.

- ◀ Mapping and alerts on – status bar icon will change to green 
- ◀ Mapping and alerts off – status bar icon will change to red 

### Applied alert

When entering or exiting an applied area, an audio alert will sound and section indicators will flash as each section needs to be turned on/off.

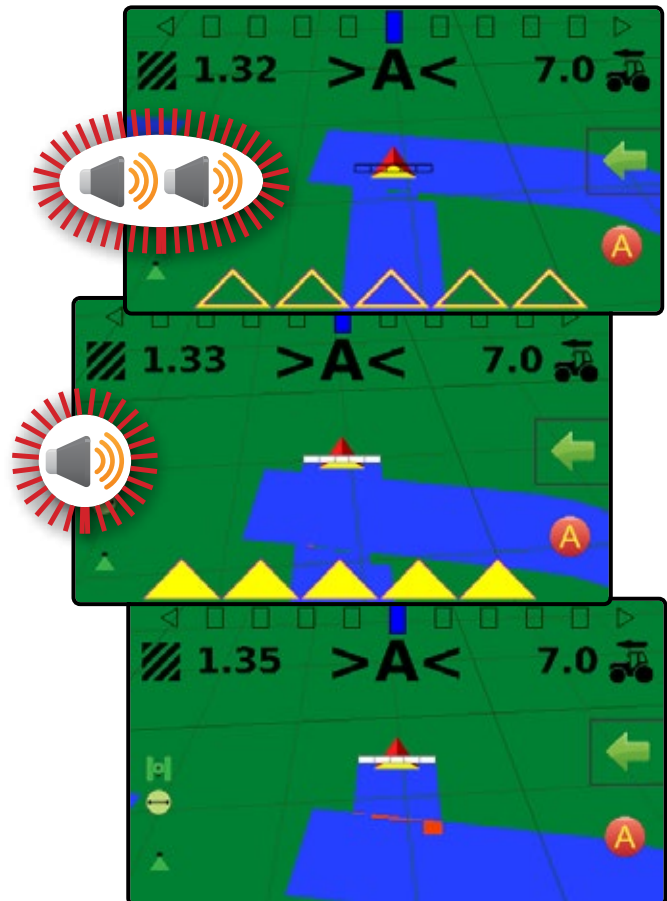

- ◀ Two beeps – entering an applied area; section mapping will turn off
- ◀ One beep – exiting an applied area; section mapping will turn on

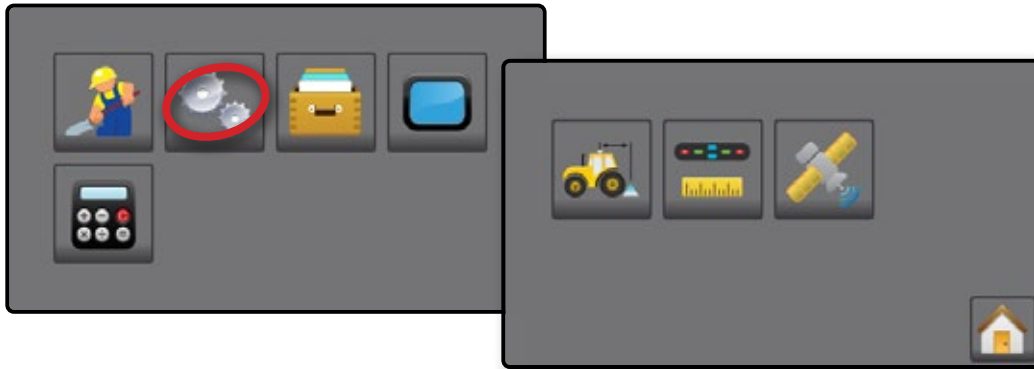

## CONFIGURATION



### Machine settings

1. From the Home screen, press CONFIGURATION button .
2. Press MACHINE CONFIGURATION button .
3. Press current value and use the keyboard to enter a new value.
  - ▶ Number of implement sections **1** – used to select the number of implement sections. Range is 1 to 7 sections.
  - ▶ Section widths **2** – used to enter the width of each section. Each section can be a different width. Range for each section is 0.0 to 246.06 feet / 0.0 to 75.0 metres. Total for all sections must be greater than 3.28 feet / 1.0 metre.
  - ▶ In-line implement offset distance **3** – used to define the in-line distance from the GNSS antenna to the implement. Range is 0.0 to 164.04 feet / 0.0 to 50.0 metres.
  - ▶ Lateral implement offset distance **4** – used to define the lateral distance from the center line of the machine to the center of the implement.
 

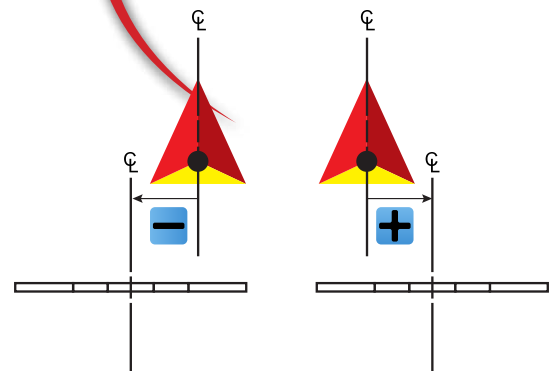
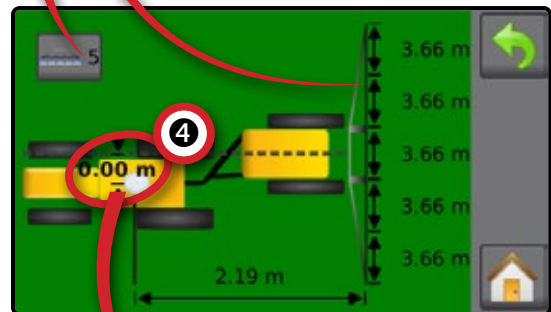
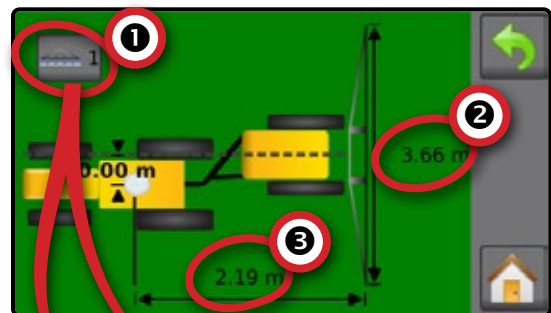

While facing in the machine's forward direction:

    - ◀ Right of center – use a positive value
    - ◀ Left of center – use a negative value
 Range is 0.0 to +/-32.8 feet / 0.0 to +/-10.0 metres.



## Lightbar spacing

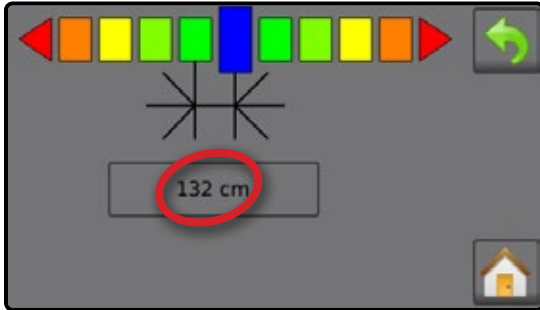

Lightbar spacing is used to set the distance away from the guideline or vehicle each guidance screen lightbar box represents.

1. From the Home screen, press CONFIGURATION button .
2. Press LIGHTBAR SPACING button .
3. Press current value and use the keyboard to enter a new value.



## GNSS receiver configuration



Used to configure GNSS receiver type.

1. From the Home screen, press CONFIGURATION button .
2. Press GNSS button .
3. Select:
  - ▶ GPS – uncorrected signals from the GPS system
  - ▶ SBAS (e.g. EGNOS, GAGAN, MSAS, SDCM, WAAS) – adds differentially corrected signals from the SBAS system
  - ▶ GLONASS – adds uncorrected signals from the GLONASS system



## JOB DATA

Job Information provides an overview of job information including the total applied area, total time traveled and bounded area.

1. From the Home screen, press DATA button .
  - ▶ Total applied area 
  - ▶ Bounded area 





*NOTE: bounded area is only shown when a boundary is active.*

- ▶ Application time 



## Delete job data



To start a new job, delete job data from internal storage:

1. Press DATA button .
2. Press RECYCLE button .
3. Select ACCEPT icon  or CANCEL icon  accordingly.



## ALL Reports

To save reports to a USB drive:

1. Press DATA button 
2. Insert USB drive.
3. Press SAVE ALL button 



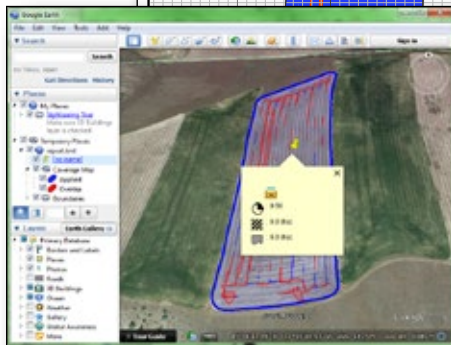
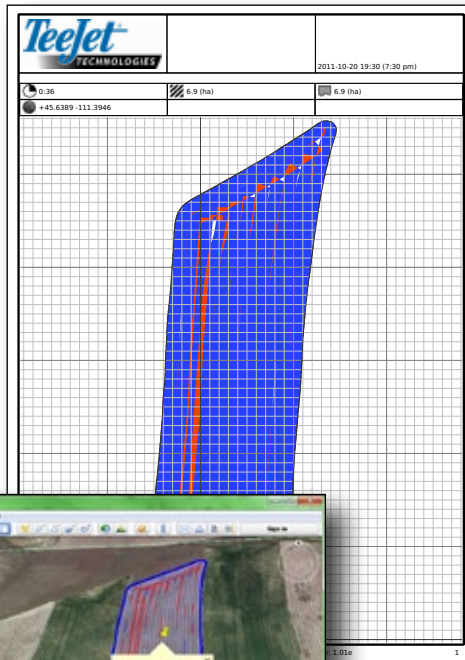
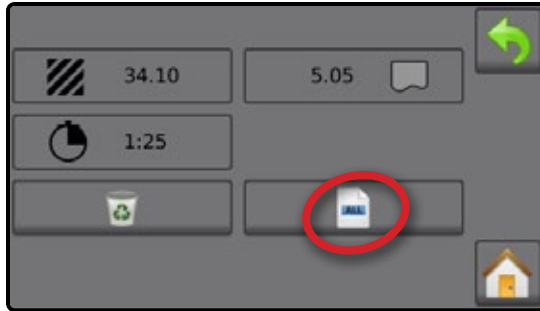







*NOTE: If no data has been collected, the SAVE ALL button will be unavailable (grayed out).*



## CONSOLE



The Console setup is used to configure the display and cultural settings.

1. From the Home screen, press CONSOLE button .
2. Select from:
  - ▶ LCD brightness  – used to adjust the brightness of the console display
  - ▶ Colour scheme  – used to change the background and text colours on the display
  - ▶ Units  – used to define the system measurements
  - ▶ Demo mode  – used to start playback of simulated GNSS data
    - ◀ GNSS  – press to use real GNSS signals
    - ◀ Demo  – press to start demonstration GNSS
  - ▶ Screenshot  – used to allow screen captures to be saved to a USB drive
  - ▶ Time zone  – used to establish the local time zone
  - ▶ About  – used to display the system software version

# MATRIX® 430

## USER GUIDE

### FIRST START-UP CONSOLE CONFIGURATION

The first time the console is started a sequence of configuration settings will be presented:

#### Units

- ▶ Select system measurements units

#### Machine settings

- ▶ Set Number of implement sections ❶
- ▶ Set Section widths ❷
- ▶ Set In-line implement offset distance ❸
- ▶ Set Lateral implement offset distance ❹

#### GNSS Receiver Configuration

The GNSS configuration menu allows the user selection of GPS, GLONASS, or SBAS when using the internal receiver. When operating under a supported SBAS system, the receiver will apply SBAS corrections to the 8 strongest GPS observations, and in addition will included up to for GLONASS observations to the solution.

Select from:

- ◀ GPS – uncorrected signals from the GPS system
- ◀ SBAS (e.g. EGNOS, GAGAN, MSAS, SDCM, WAAS) – adds differentially corrected signals from the SBAS system
- ◀ GLONASS – adds uncorrected signals from the GLONASS system

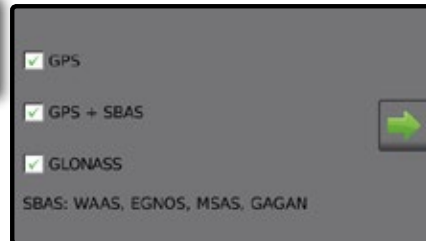
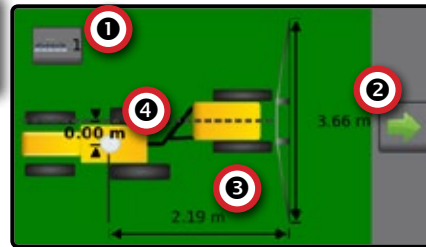
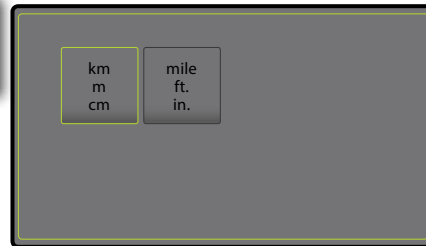

[www.teejet.com](http://www.teejet.com)

A Subsidiary of  **Spraying Systems Co.**

98-05332-EN-LT R0 English  
© TeeJet Technologies 2015

#### Copyrights

© 2015 TeeJet Technologies. All rights reserved. No part of this document or the computer programs described in it may be reproduced, copied, photocopied, translated, or reduced in any form or by any means, electronic or machine readable, recording or otherwise, without prior written consent from TeeJet Technologies.

#### Trademarks

Unless otherwise noted, all other brand or product names are trademarks or registered trademarks of their respective companies or organizations.

#### Limitation of Liability

TEEJET TECHNOLOGIES PROVIDES THIS MATERIAL "AS IS" WITHOUT WARRANTY OF ANY KIND, EITHER EXPRESSED OR IMPLIED. NO COPYRIGHT LIABILITY OR PATENT IS ASSUMED. IN NO EVENT SHALL TEEJET TECHNOLOGIES BE LIABLE FOR ANY LOSS OF BUSINESS, LOSS OF PROFIT, LOSS OF USE OR DATA, INTERRUPTION OF BUSINESS, OR FOR INDIRECT, SPECIAL, INCIDENTAL, OR CONSEQUENTIAL DAMAGES OF ANY KIND, EVEN IF TEEJET TECHNOLOGIES HAS BEEN ADVISED OF SUCH DAMAGES ARISING FROM TEEJET TECHNOLOGIES SOFTWARE.